



ANELTEC



***Articoli tecnici
per l'edilizia***



***Technical articles
for the building***

Produzione e vendita di guarnizioni, trafilati in gomma,
distanziatori e articoli tecnici per l'edilizia.

ANELTEC srl

Sede: Via Tagiura, 10 - 20146 Milano

Tel. +39 02 42.23.343 - Fax +39 02 48.95.24.70

Stabilimento: Via G. Ferraris, 11 - Cusago (MI)



ANELTEC

ANELTEC

ANELTEC

ANELTEC

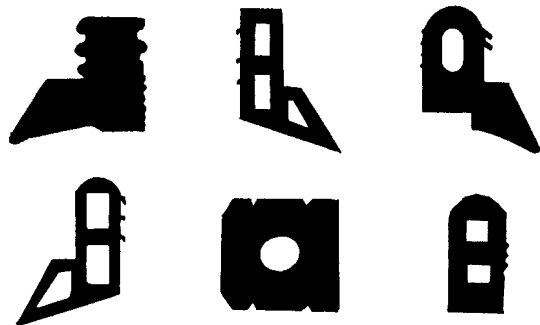

- GUARNIZIONI ANTIOLIO PER CASSEFORME
- PIASTRE APPOGGIO IN NEOPRENE
- TRAFILATI IN GOMMA



LISTINO PREZZI 2000

- GUARNIZIONI ANTIOLIO PER CASSEFORME
- PIASTRE APPOGGIO IN NEOPRENE
- TRAFILATI IN GOMMA

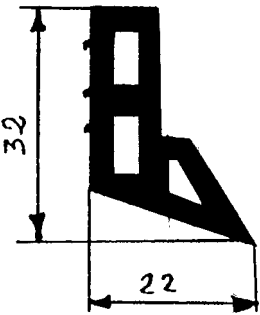
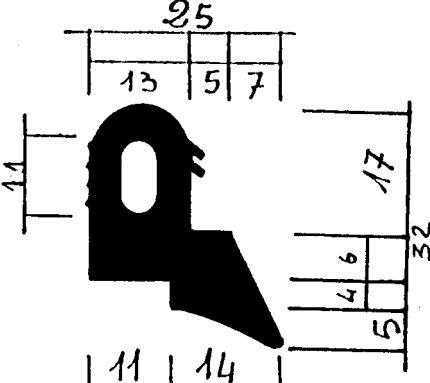
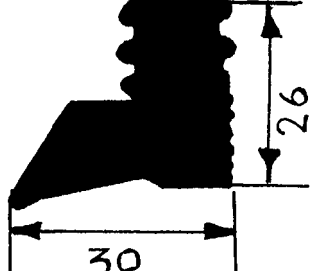
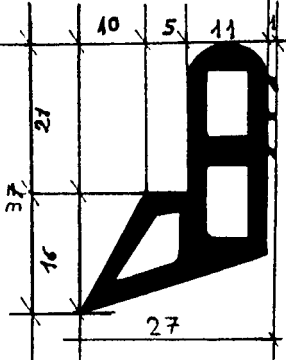
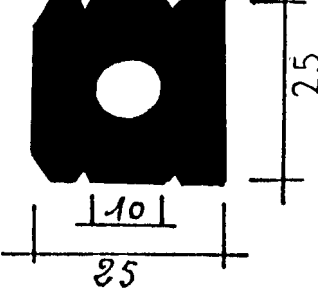
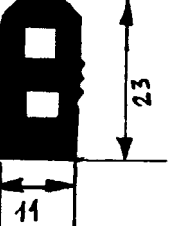
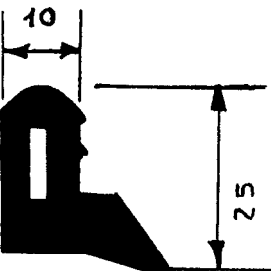
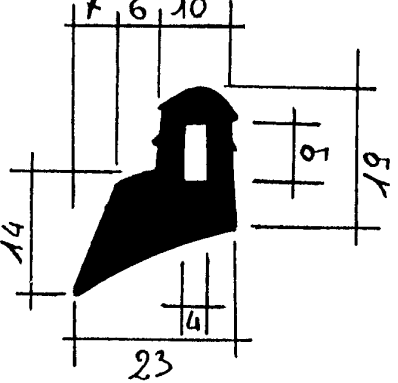
LISTINO PREZZI 2000

		
<p>ART. 3001 L./mt. 3.260</p>	<p>ART. 3002 L./mt. 6.050</p>	<p>ART. 3003 L./mt. 9.640</p>
		
<p>ART. 3004 L./mt. 4.610</p>	<p>ART. 3005 L./mt. 9.150</p>	<p>ART. 3006 L./mt. 2.900</p>
		
<p>ART. 3007 L./mt. 4.800</p>	<p>ART. 3008 L./mt. 4.450</p>	<p>ART. 3009 L./mt. 3.500</p>

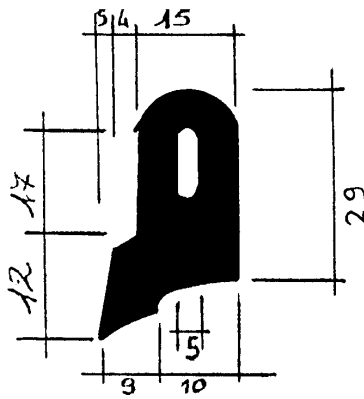

ART. 3010 L./mt. 7.700

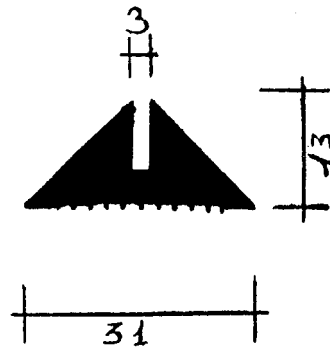

ART. 3011 L./mt. 3.850

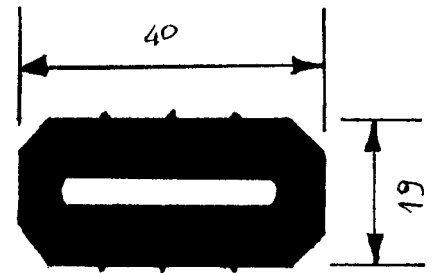

ART. 3012 L./mt. 9.450

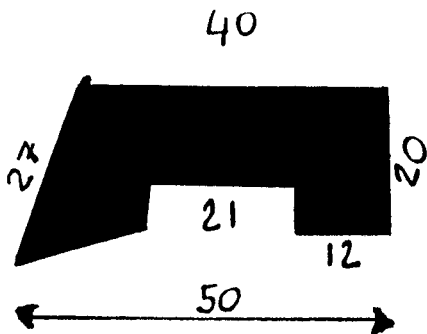

ART. 3013 L./mt. 13.100

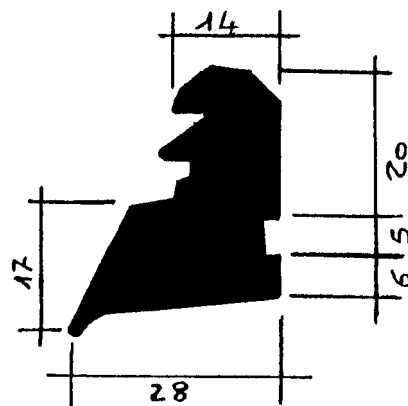

ART. 3014 L./mt. 8.950

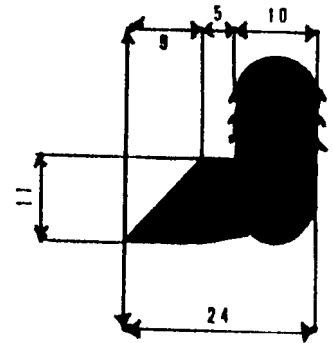

ART. 3015 L./mt. 5.750

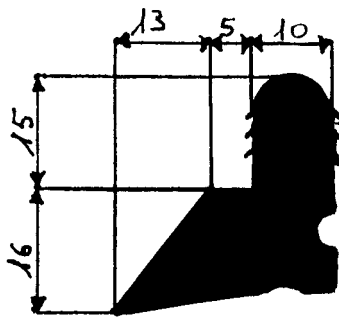

ART. 3016 L./mt. 7.950

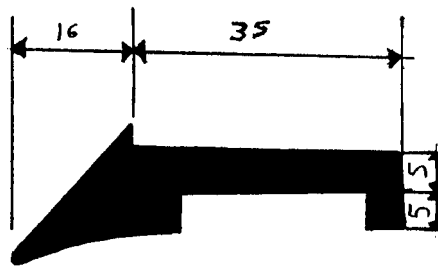

ART. 3017 L./mt. 6.800

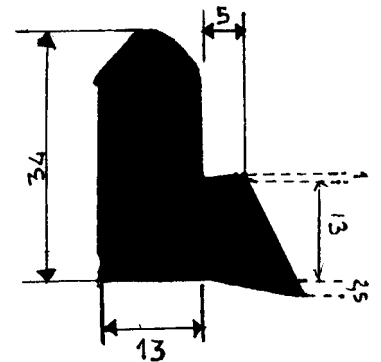

ART. 3018 L./mt. 6.450

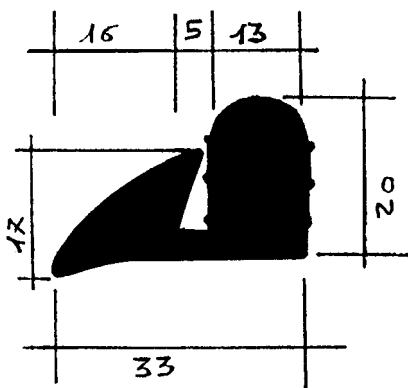

ART. 3019 L./mt. 6.850

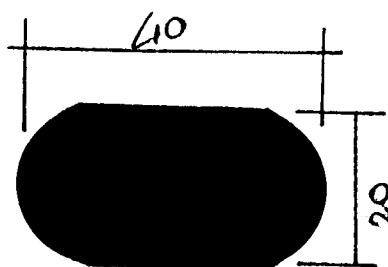

ART. 3020 L./mt. 11.400

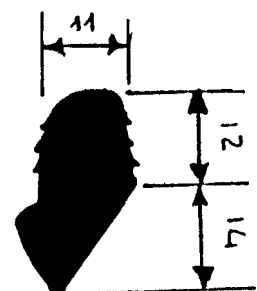

ART. 3021 L./mt. 4.100

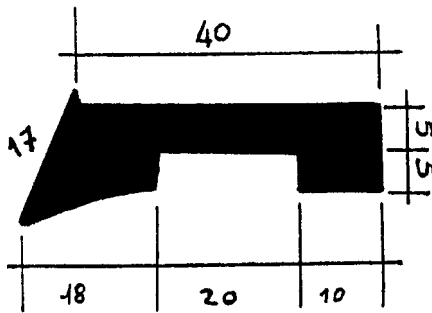

ART. 3022

L./mt. 6.850

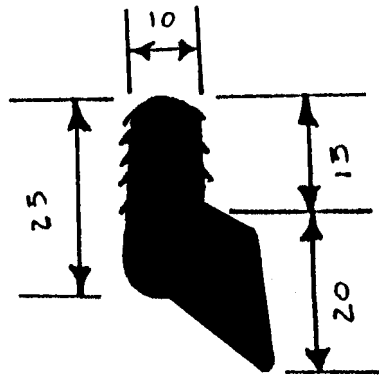

ART. 3023

L./mt. 7.150

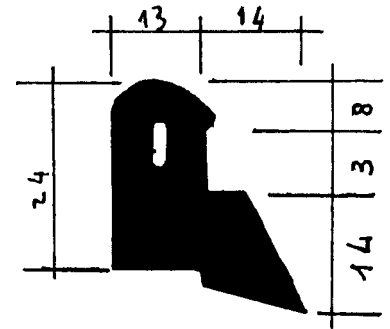

ART. 3024

L./mt. 6.900

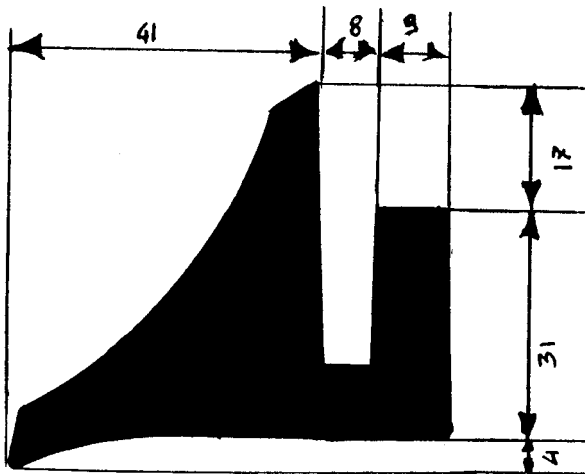

ART. 3025

L./mt. 31.000

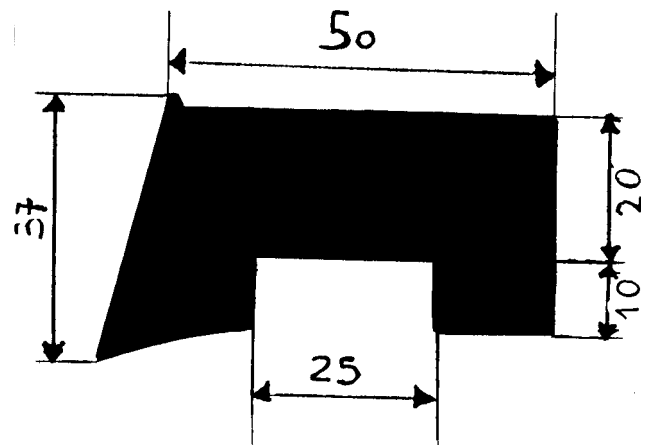

ART. 3026

L./mt. 26.100

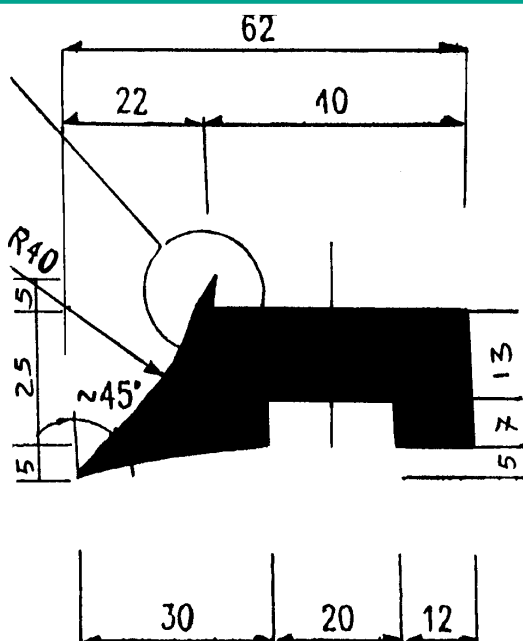

ART. 3027

L./mt. 16.300

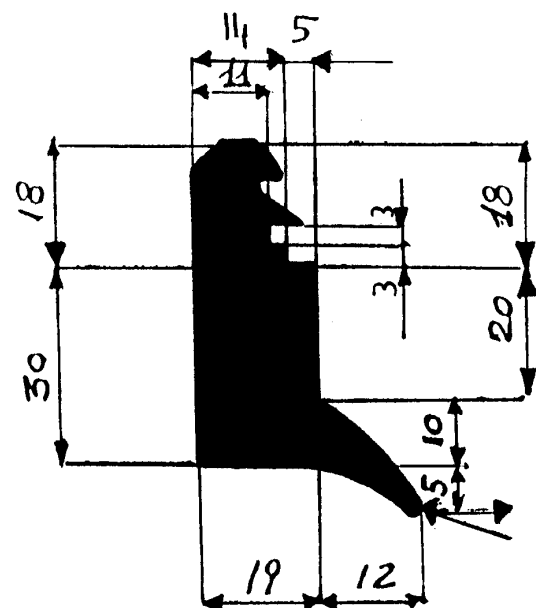

ART. 3028

L./mt. 15.500

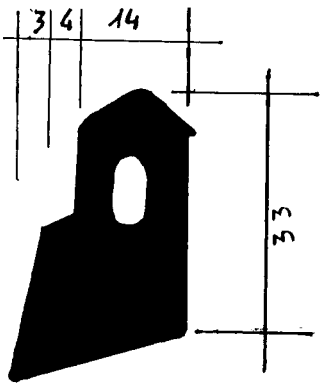

ART. 3029 L./mt. 9.200

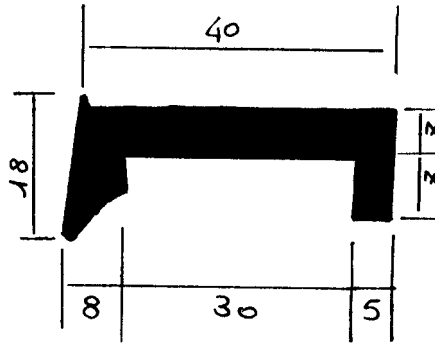

ART. 3030 L./mt. 5.600

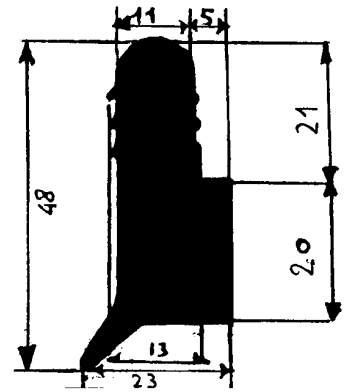

ART. 3031 L./mt. 10.900

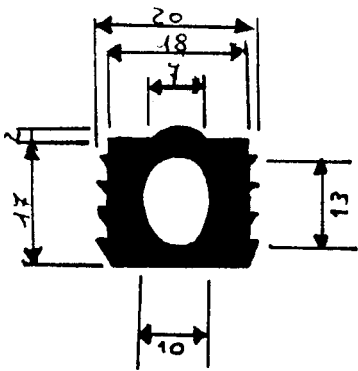

ART. 3032 L./mt. 3.800

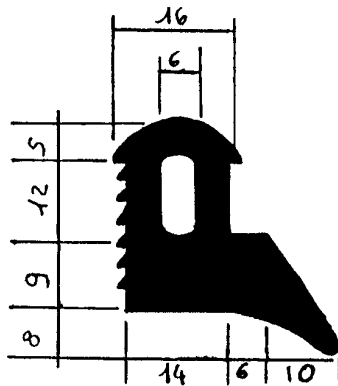

ART. 3033 L./mt. 8.450

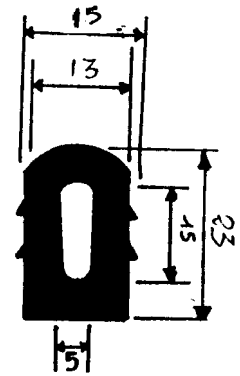

ART. 3034 L./mt. 3.750

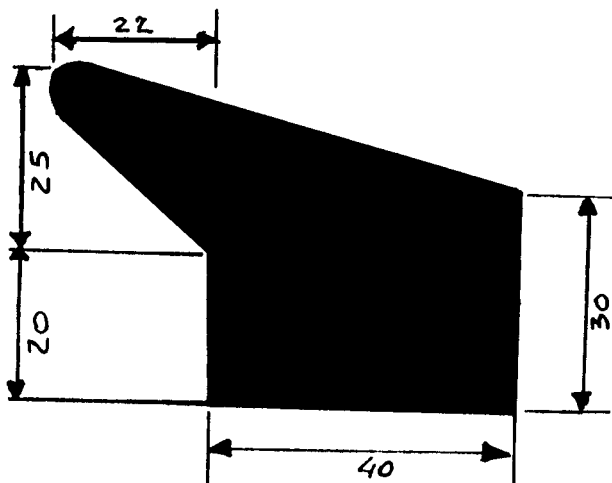

ART. 3035 L./mt. 28.100

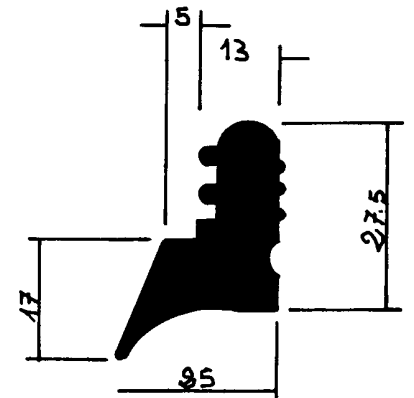

ART. 3036 L./mt. 7.200

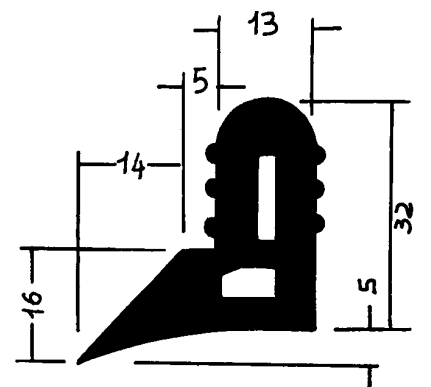

ART. 3037 L./mt. 8.400

<p>ART. 3038 L./mt. 5.850</p>	<p>ART. 3039 L./mt. 9.350</p>	<p>ART. 3040 L./mt. 3.300</p>
<p>ART. 3041 L./mt. 9.850</p>	<p>ART. 3042 L./mt. 8.650</p>	<p>ART. 3043 L./mt. 3.050</p>
<p>ART. 3044 L./mt. 8.900</p>	<p>ART. 3045 L./mt. 3.850</p>	<p>ART. 3046 L./mt. 7.900</p>
<p>ART. 3047 L./mt. 6.350</p>	<p>ART. 3048 L./mt. 19.400</p>	<p>ART. 3049 L./mt. 9.150</p>

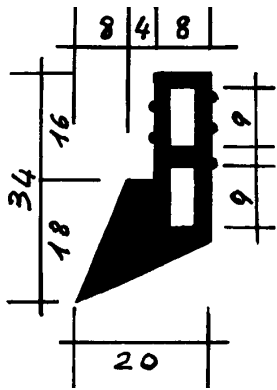

ART. 3050 L./mt. 4.350

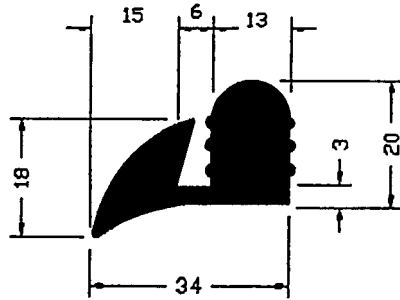

ART. 3051 L./mt. 6.550

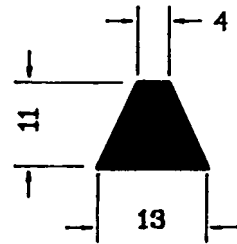

ART. 3052 L./mt. 1.700

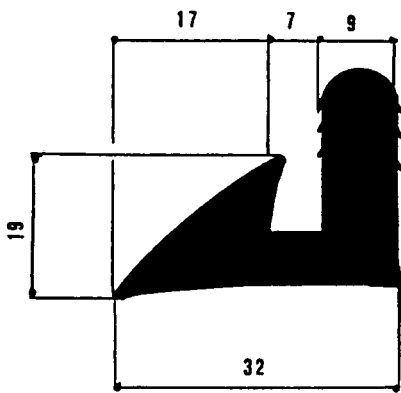

ART. 3053 L./mt. 6.300

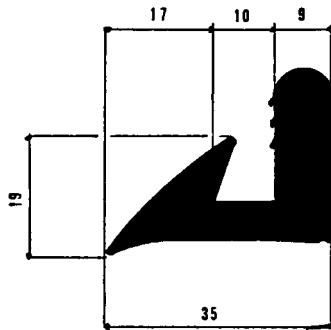

ART. 3054 L./mt. 6.550

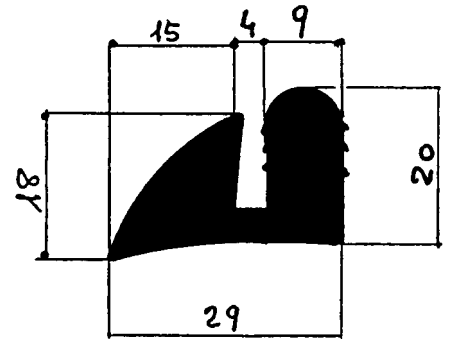

ART. 3055 L./mt. 6.350

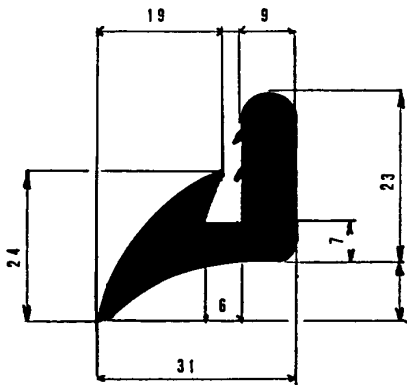

ART. 3056 L./mt. 6.400

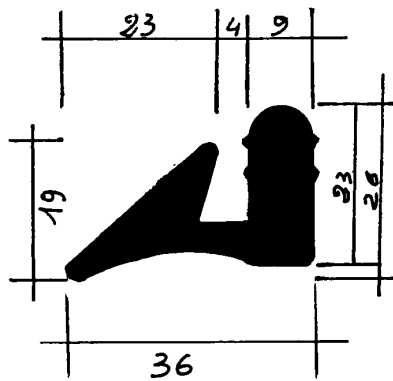

ART. 3057 L./mt. 6.450

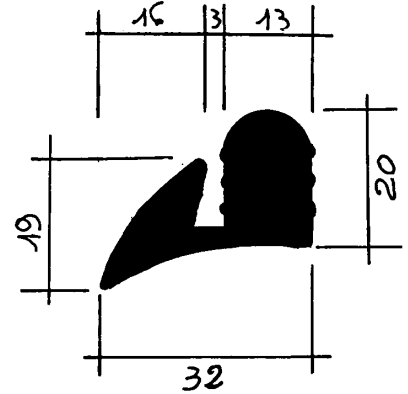

ART. 3058 L./mt. 5.800

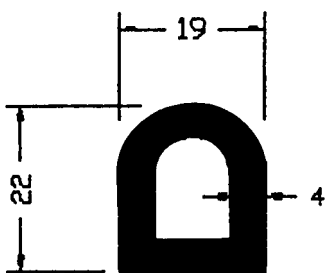

ART. 3059 L./mt. 4.180

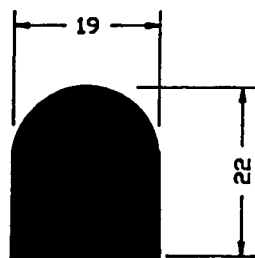

ART. 3060 L./mt. 7.300

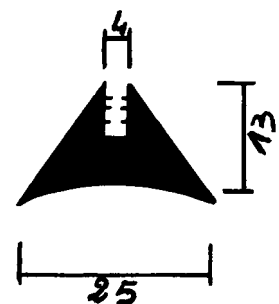

ART. 3061 L./mt. 3.050

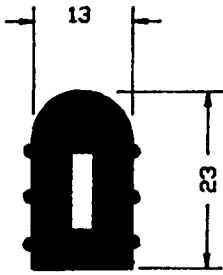

ART. 3062

L./mt. 4.270

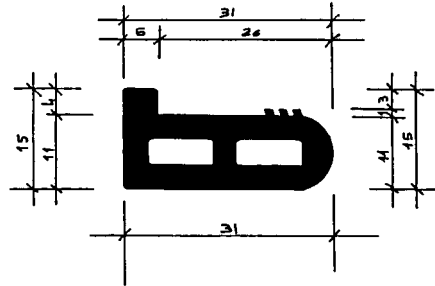

ART. 3063

L./mt. 4.730

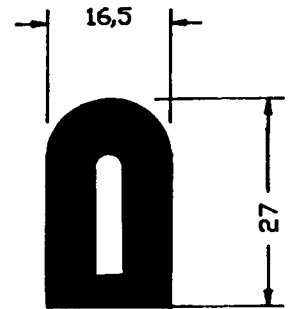

ART. 3064

L./mt. 6.180

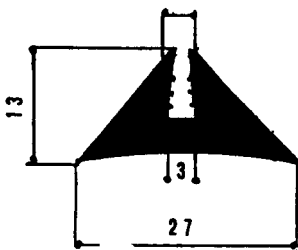

ART. 3065

L./mt. 3.050

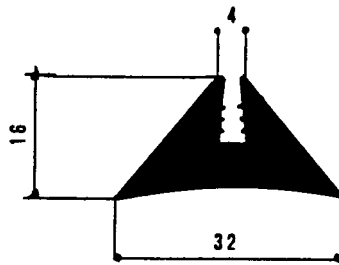

ART. 3066

L./mt. 4.880

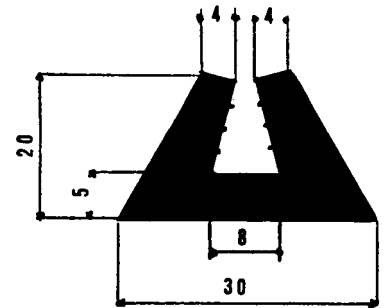

ART. 3067

L./mt. 5.620

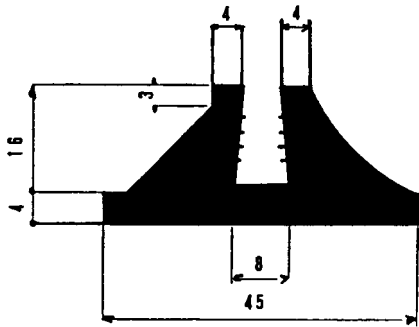

ART. 3068

L./mt. 8.170

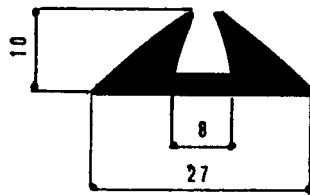

ART. 3069

L./mt. 2.440

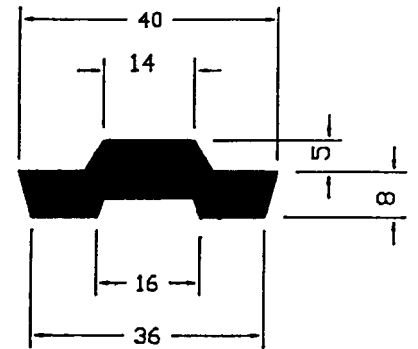

ART. 3070

L./mt. 5.480

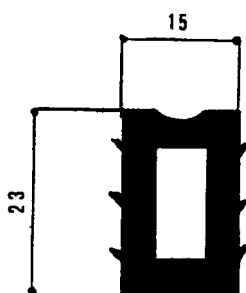

ART. 3071

L./mt. 4.520

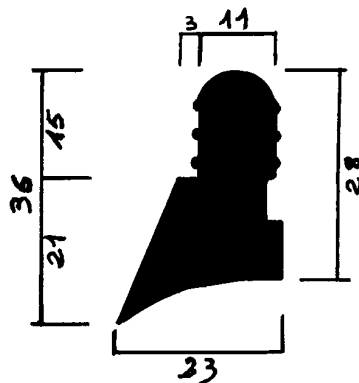

ART. 3072

L./mt. 6.800

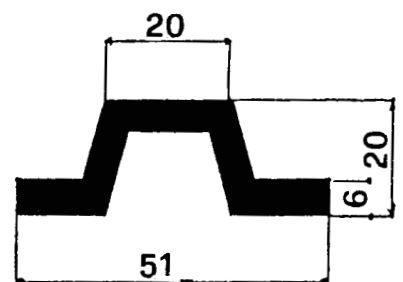

ART. 3073

L./mt. 7.320

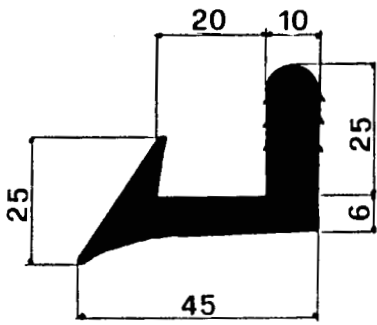

ART. 3074

L./mt. 9.760

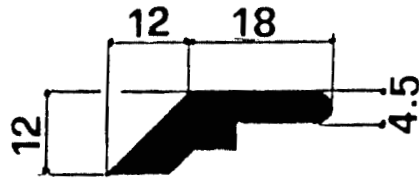

ART. 3075

L./mt. 3.050

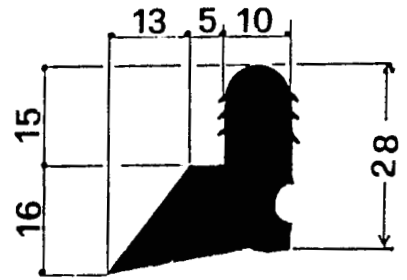

ART. 3076

L./mt. 17.050

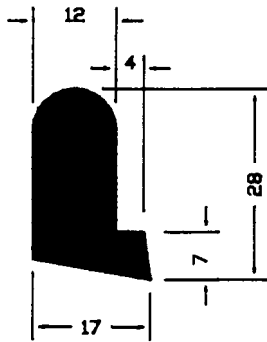

ART. 3077

L./mt. 4.100

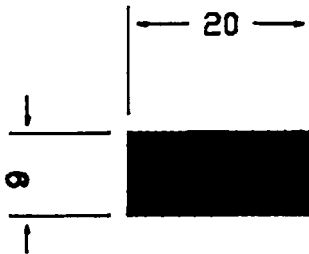

ART. 3078

L./mt. 3.160

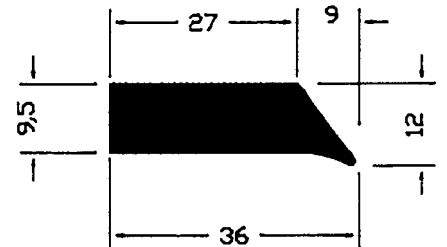

ART. 3079

L./mt. 5.480

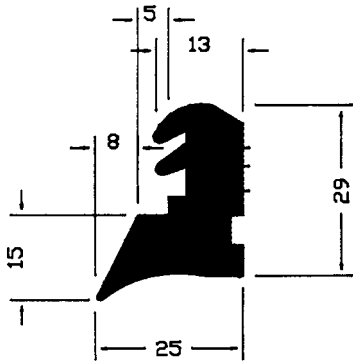

ART. 3080

L./mt. 7.920

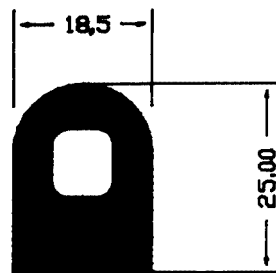

ART. 3081

L./mt. 7.320

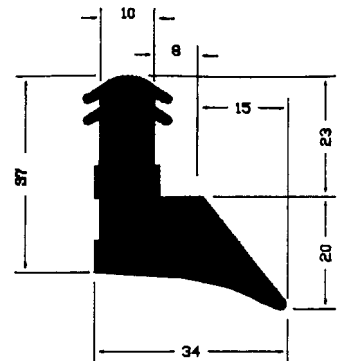

ART. 3082

L./mt. 9.760

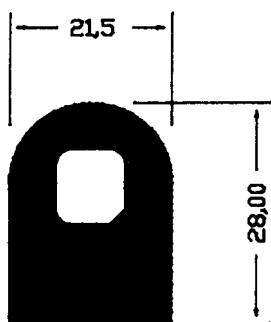

ART. 3083

L./mt. 9.740

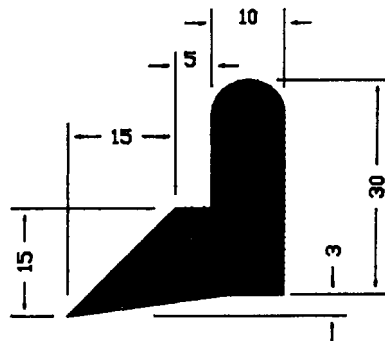

ART. 3084

L./mt. 7.800

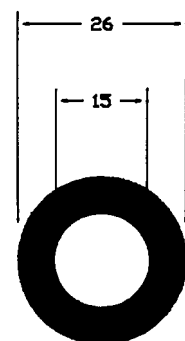

ART. 3085

L./mt. 6.400

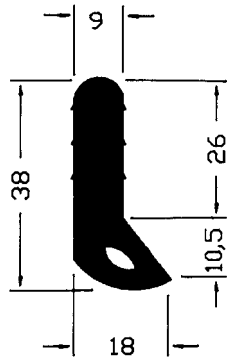

ART. 3086

L./mt. 6.120

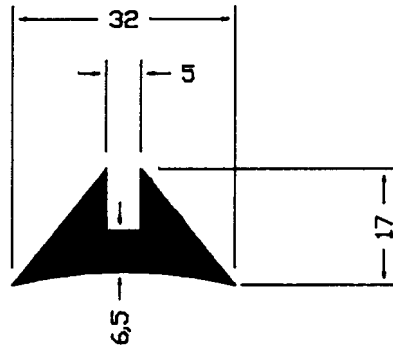

ART. 3087

L./mt. 5.200

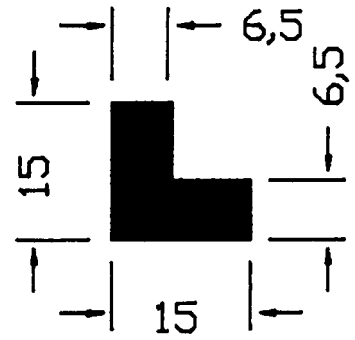

ART. 3088

L./mt. 3.050

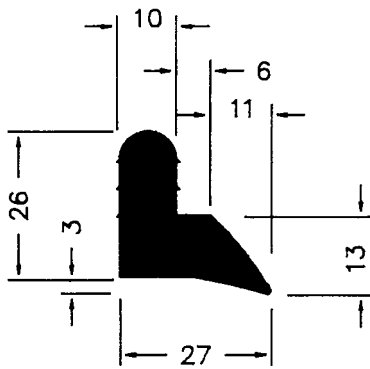

ART. 3089

L./mt. 6.100

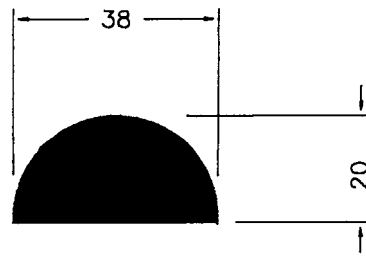

ART. 3090

L./mt. 8.780

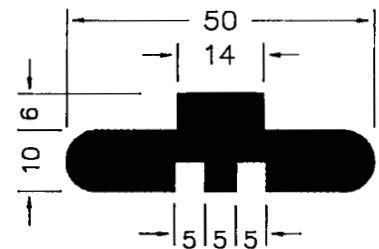

ART. 3091

L./mt. 9.150

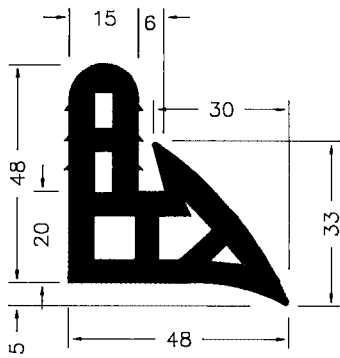

ART. 3092

L./mt. 19.500

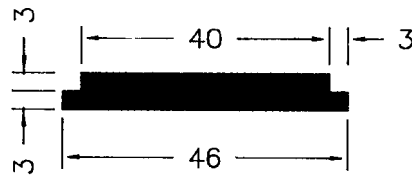

ART. 3093

L./mt. 4.630

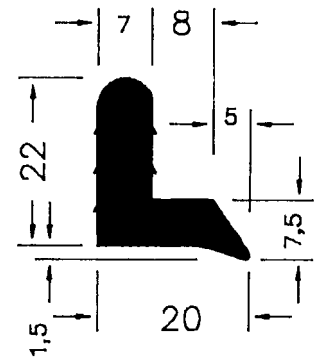

ART. 3094

L./mt. 4.180

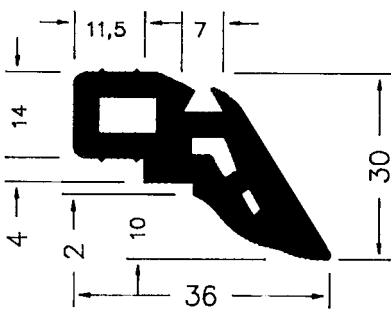

ART. 3095

L./mt. 9.900

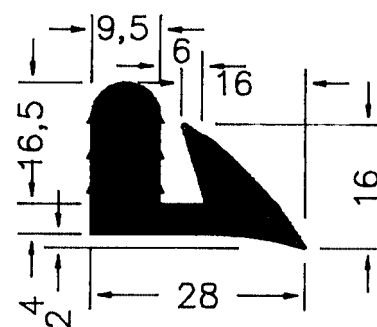

ART. 3096

L./mt. 6.100

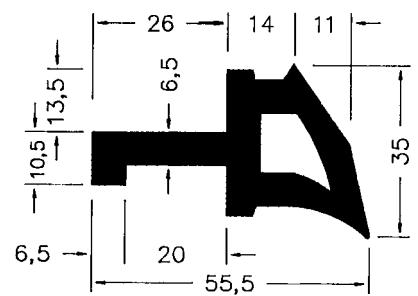

ART. 3097

L./mt. 13.420

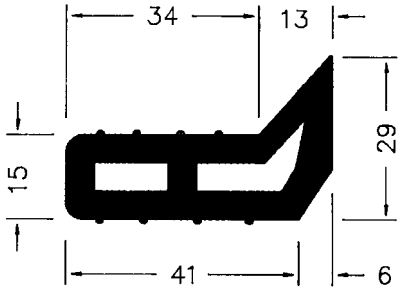
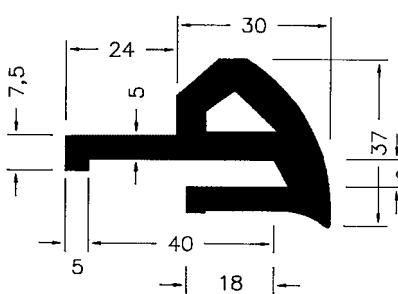
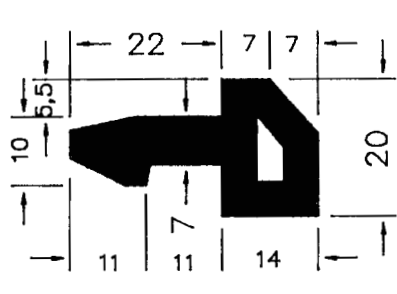
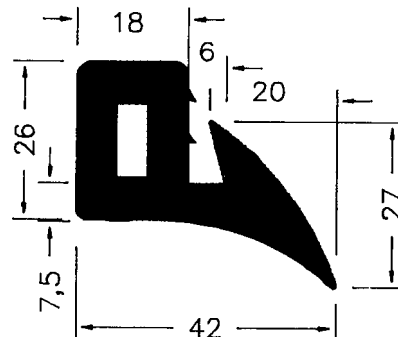
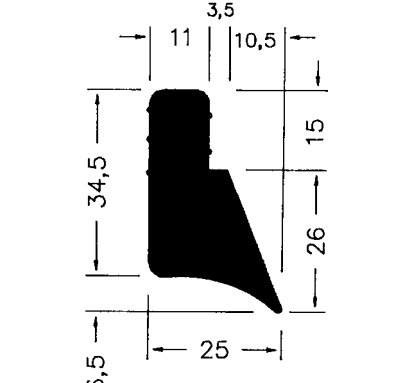
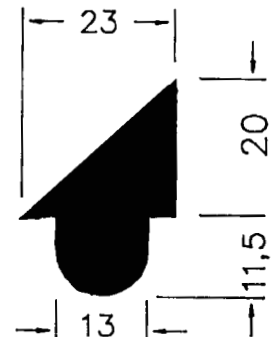
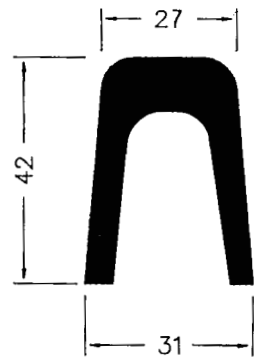
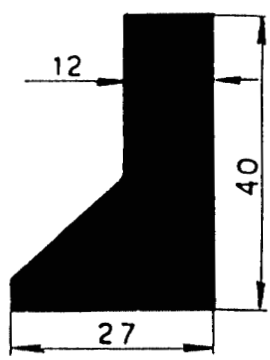
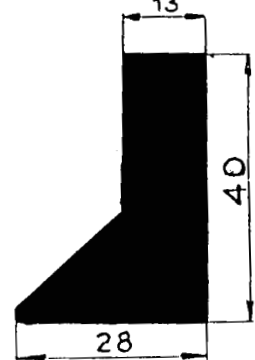
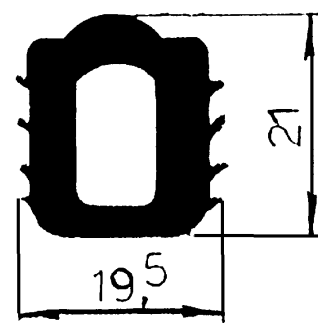
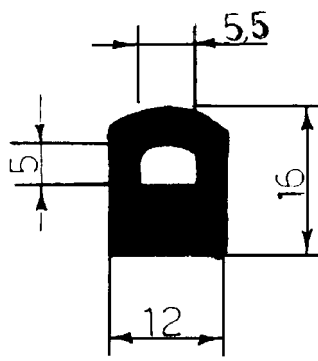
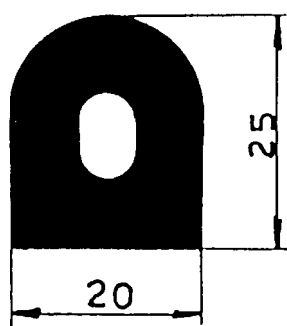
		
<p>ART. 3098 L./mt. 10.900</p>	<p>ART. 3099 L./mt. 14.640</p>	<p>ART. 3100 L./mt. 6.950</p>
		
<p>ART. 3101 L./mt. 12.200</p>	<p>ART. 3102 L./mt. 9.760</p>	<p>ART. 3103 L./mt. 5.490</p>
		
<p>ART. 3104 L./mt. 8.540</p>	<p>ART. 3105 L./mt. 13.800</p>	<p>ART. 3106 L./mt. 13.800</p>
		
<p>ART. 3107 L./mt. 3.900</p>	<p>ART. 3108 L./mt. 3.600</p>	<p>ART. 3109 L./mt. 9.100</p>

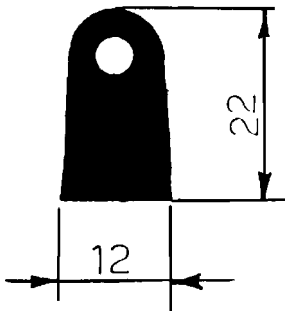

ART. 3110 L./mt. 3.800

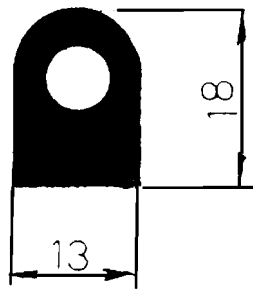

ART. 3111 L./mt. 3.400

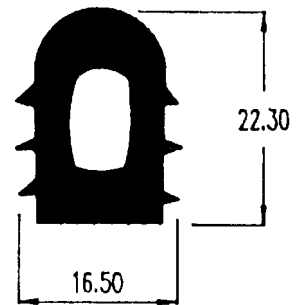

ART. 3112 L./mt. 4.300

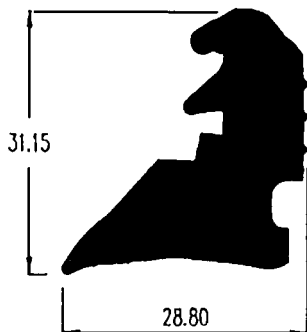

ART. 3113 L./mt. 7.950

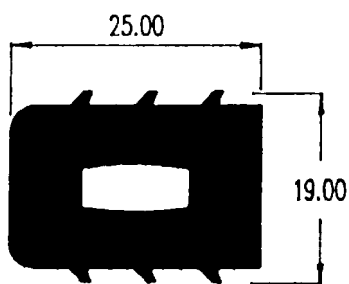

ART. 3114 L./mt. 5.150

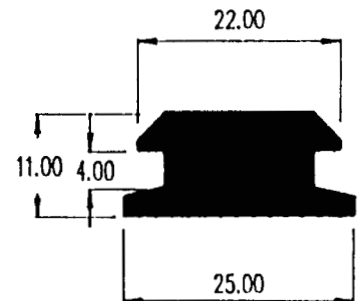

ART. 3115 L./mt. 5.800

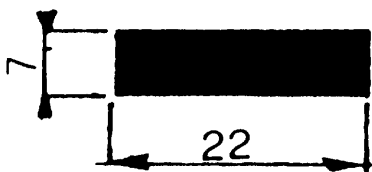

ART. 3116 L./mt. 2.190

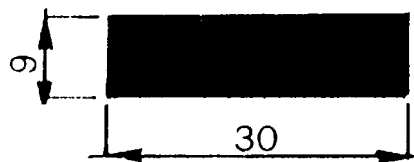

ART. 3117 L./mt. 4.050

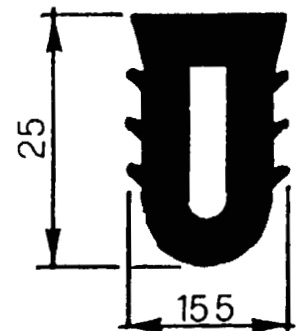

ART. 3118 L./mt. 3.900

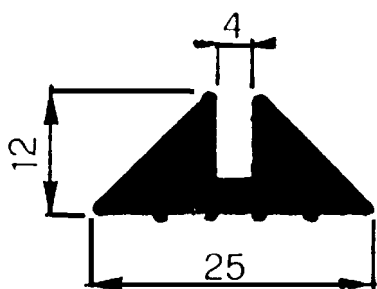

ART. 3119 L./mt. 2.700

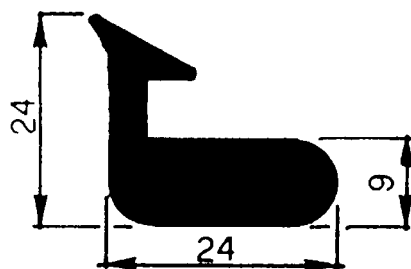

ART. 3120 L./mt. 4.350

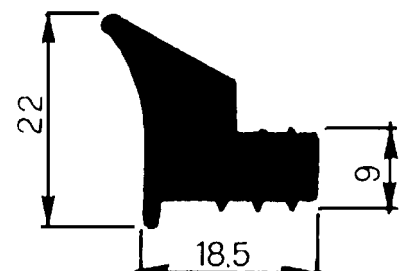

ART. 3121 L./mt. 4.030

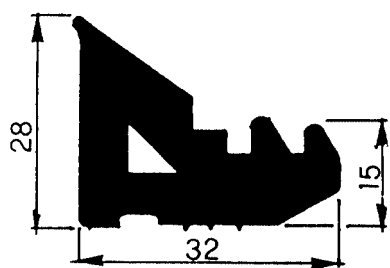

ART. 3122 L./mt. 7.680

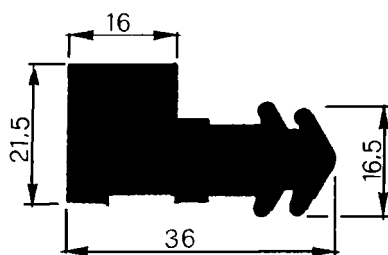

ART. 3123 L./mt. 8.480

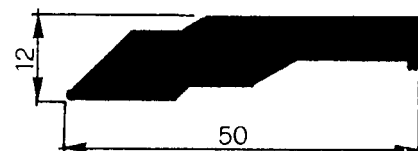

ART. 3124 L./mt. 6.200

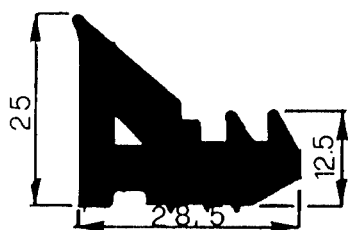

ART. 3125 L./mt. 7.320

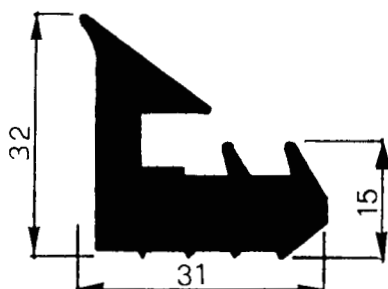

ART. 3126 L./mt. 8.120

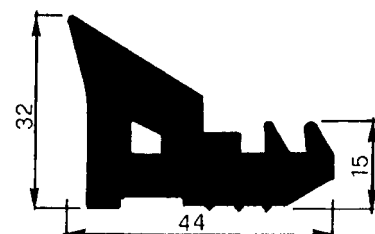

ART. 3127 L./mt. 10.500



ART. 3128 L./mt. 6.220

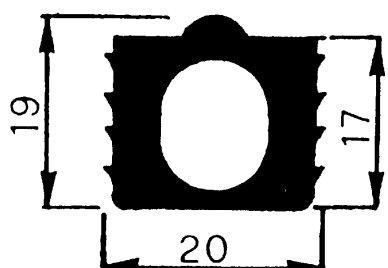

ART. 3129 L./mt. 3.250

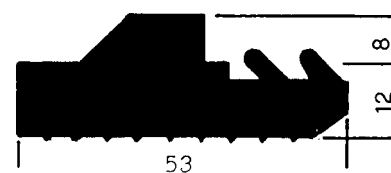

ART. 3130 L./mt. 11.950

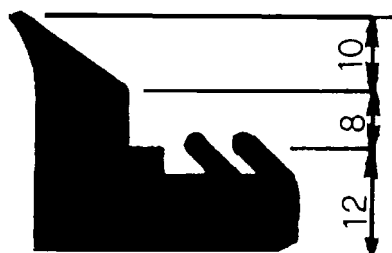

ART. 3131 L./mt. 7.950

**FORNIAMO TRAFILATI IN GOMMA
CON OGNI TIPO DI MESCOLO,
REALIZZATI SU DISEGNO
O A CAMPIONE**

- PIASTRE DI APPOGGIO IN NEOPRENE
- ARMATE E NON ARMATE
- TRAFILATI IN GOMMA

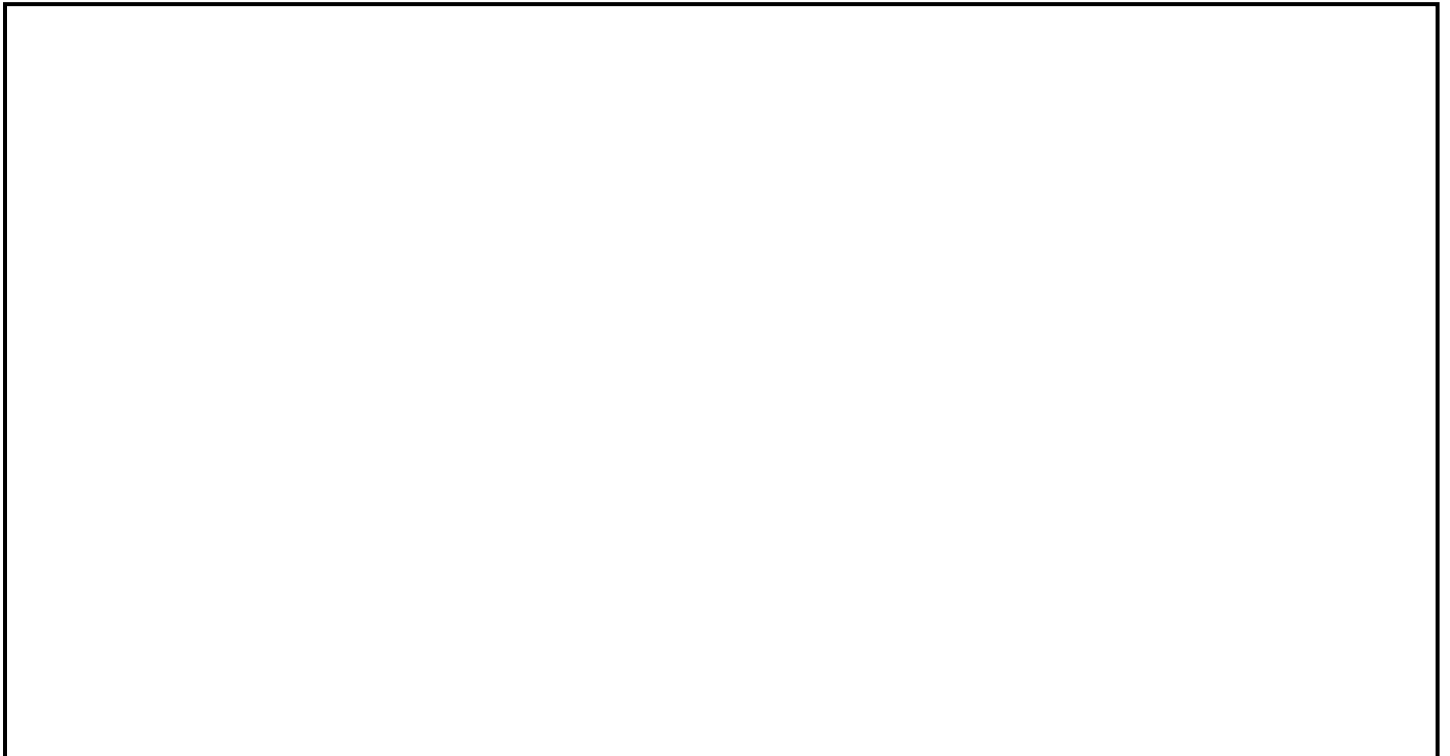

- Apparecchi di appoggio in neoprene / anche armati.
- Apparecchi di appoggio in acciaio - acciaio / teflon.
- Giunti strutturali varie escursioni.
- Ammortizzatori di estremità per opere edili industriali.
- Ammortizzatori in gomma e gomma / acciaio completi di sistemi di ancoraggio per ponti e bacini.
- Articoli tecnici industriali in gomma / gomma / metallo.

**Il ns. ufficio vendite è a completa disposizione per
fornire tutti i dettagli tecnici e
per sottoporVi le ns. migliori quotazioni.**



20146 Milano
Via Tagiura, 10
telefono 02/42.23.343
telefax 02/48.95.24.70

ANELTEC

Stabilimento:
Cusago (MI) - Via G. Ferraris, 11
P. IVA: 06159660965
Cod. Fisc.: BFF RRT 56L05 A191D
C.C.I.A.A.: 1112862